

Pro Shop Clamp

1693.1Q









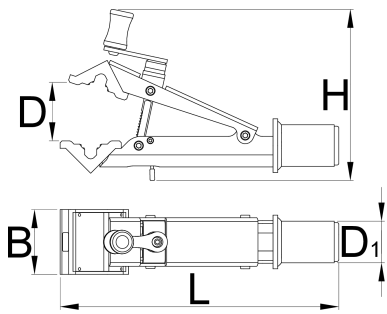

Profili



Atributi proizvoda

- Pro Shop Clamp is Unior's high-end offer for bike shops. It features advanced quick release system that enable quick and efficient work on any bicycle.
- Quick release system enables the mechanic to press the jaws by hand, at which point clamp already grips the seat post of a frame with sufficient force to hold the bicycle in place. Rotate the handle and additional tension is applied to the jaws to ensure firm grip.
- Clamp can grip tubes of any shape, with diameter of minimum Ø22mm to maximum Ø60mm.
- Pro Shop Clamp has a quick release button, which is used to release the jaws after initial tension release with the rotating handle.
- Height of the jaws is 70mm, so it works with smaller sizes of seat posts as well as with dropper posts.
- The clamp is compatible with all of Unior's repair stands.



							
627095	22	60	70	185	300	45	1730

* Slike proizvoda su simbolične. Sve dimenzije su u mm, masa je u g.

upotreba (pictures)

