

Embout fileté

1507Z7

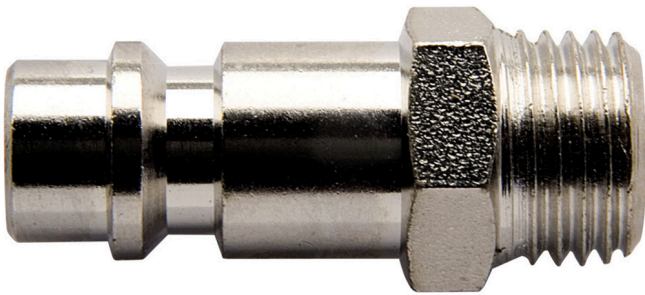







Profils

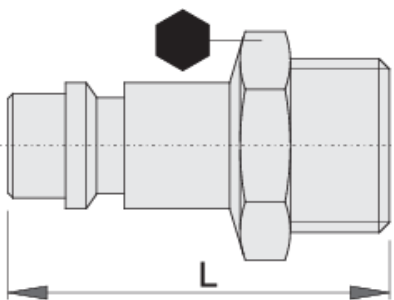

Description produit

- Diamètre interne du tuyau : 7 mm
- Filetage mâle
- Enveloppe métallique



|  |  mm |  mm |  L |  |
|--|---|---|--|---|
| 617797 | R1/4" | 14 | 34 | 24 |
| 617798 | R3/8" | 19 | 36.5 | 34 |



618483

R1/2"

22

39

40

* Les images des produits ne sont pas contractuelles. Toutes les dimensions sont en mm, les poids en grammes.