

Stalak za centriranje kotača - za hobi korisnike

1688



Profili









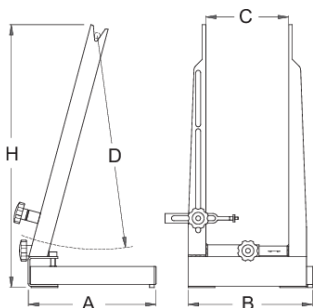

Atributi proizvoda

- Materijal: Premium Flex Plus konstrukcijski čelik
- Pogodno za centriranje kotača dimenzija od 16 do 29 col-a, s gumom ili bez.
- za glave kotača širine do 157 mm
- Stalak je prije svega namijenjen hobi majstorima. Jednostavan je za korištenje, lagan je (2,3 kg), te ne zauzima mnogo prostora. Lijevi nosač je fiksiran na donji profil, desni je pomičan zbog različitih dužina osovina bicikala.

Kako upotrijebiti alat:

- Stalak slažemo tako da nožicu zatvorimo u donji profil.
- Postolje pomoću vijaka možemo pričvrstiti na radnu površinu te mu tako povećati stabilnost.
- Kontrolna tipka je jednostrana, stoga kotač centriramo prvo s jedne strane, potom ga okrećemo te centriramo s druge strane.
- Dodatna funkcija omogućava kontrolu centričnosti diskova



							
623060	760	90	172	218	217	463	2300

* Slike proizvoda su simbolične. Sve dimenzije su u mm, masa je u g.

upotreba (pictures)

