

Съединител, мъжки

1507Z10

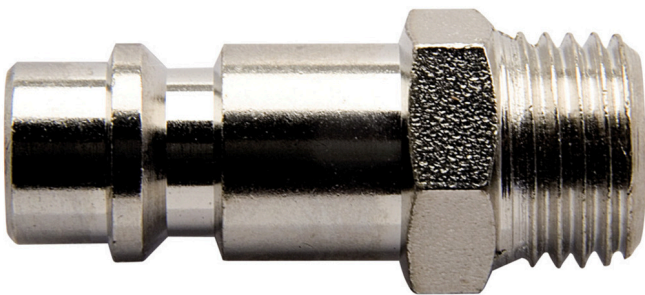







Профили

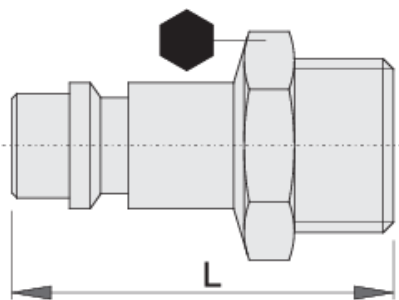

Параметри на продукта

- външна резба
- вътрешен диаметър Ø10 мм
- метален кожух



				
621455	3/8"	17	39.4	38
621456	1/2"	24	39.4	53



621457

3/4"

27

48.5

86

* Снимките на продуктите са символични. Всички размери са в мм., теглото е в грамове .